

Roof Top Tent Manual



Installation Manual

Congratulations on your purchase of a Roof Top Tent. We strive to provide the ultimate camping experience for every camper. Your high quality durable roof top tent mounts directly to your roof rack or aftermarket roof bars. The tent opens and is fully setup in just a few minutes and can easily be left on your vehicle year round.

Your Roof Top roof top tent is made with the most durable materials that will stand up to the most extreme conditions. We use high quality rip-stop fabrics with superior ventilate coating that provide excellent water and wind protection yet are more breathable than other tent brands on the market.

Most of your Roof Top Tent components have been fully assembled at the factory with the exception of attaching the mounting channels and the ladder to the base of the tent. Tent setup is composed of unpacking, attaching mounting channels to the base of the tent, attaching the ladder, attaching the tent cover, and then mounting your Tepui Tent onto your roof rack or aftermarket roof bars.

Should you have any questions, please Contact the customer Service.







WARNING

Improper installation or use of your tent may result in serious injury or death. You will need to follow these installation instructions carefully to ensure proper installation on your vehicle and safe use of your tent. Please check with your vehicle manufacture for specified loading capacity of your roof rack. Not all factory roof racks or aftermarket roof bars can safely accommodate Tent models.

Table of Contents

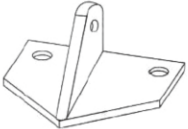
Hardware Identification Chart.....	3
Tent Orientation on Your Vehicle.....	4
Attaching Mounting Channels	5
Attaching Ladder.....	6
Placement of Roof top Tent onto your Roof Rack Bars	7
Cover Attachment	8
Tent Setup	9
Vestibule Attachment Instructions.....	12
Storage and Handling.....	13
Limited Warranty	14

Hardware Identification Chart

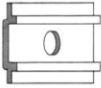
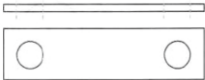
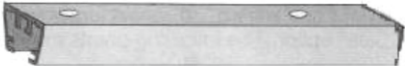
Item	Quantity	Picture
13 mm Steel Bolt	12	
13 mm Nylock Nut	8	
10 mm Nylock Nut	12	
Ladder Mounting Bracket	2	
Stainless Steel Washer	24	
10 mm Stainless Steel Bolt to Mount Ladder	2	
Metric Wench 10mm/8mm	1	
Metric Wench 11mm/13mm	1	
Aluminum Slide Plate	8	
Steel Mount Plate	4	
Mounting Channel	2	

Tent Orientation on Your Vehicle

There are two mounting options for the orientation of your new Tent. Either the tent will open so that the ladder extends off the back of your vehicle, "Rear Mounted," or the ladder extends off the side of you vehicle, "Side Mounted".



Rear Mounted



Side Mounted

Either orientation will work for larger vehicles, however, most sedans or smaller SUVs are better suited for the side mounted option.

Benefits for the rear mounted orientation:

1. Fits into narrow camping spaces.
2. You can access the trunk or tail gate area at the rear of your vehicle from inside the vestibule (Autana Model Only).

Benefits for the side mounted orientation:

1. Allows for bicycle racks and other tow hitch/bar accessories to be installed without interfering with your tent operation.
2. Closed tent width will fit inside the roof dimensions of most cars and SUV's. i.e. the tent base will not extend beyond the roof line of your vehicle when closed.

The Kukenam is square so the mounting channels fit within the tent base in both orientations. If the Autana model is side mounted the mounting channels need to be cut to match the width of the tent base. We will go over this in the next section.

Attaching Mounting Channels

Remove tent from box and place on clean surface. Observe top surface. If it has four holes in the center area of the base then this is the side which will receive the mounting channels. Otherwise you are looking at the surface which will receive the ladder. Open tent to gain entrance to interior and remove contents.



After removing contents, close tent so channel mounting surface is facing upward (side with 4 holes).

Using four supplied 6mm bolts and 6mm washers, slide your hand between base and mattress and insert bolts with washers into the pre-drilled holes. (You may need to poke holes through the tape to insert bolts.)

Place mounting channels on exposed bolts. For side mounted orientation, ensure mounting channels are perpendicular to hinge side. For rear mounted orientation, ensure mounting channels are parallel to hinge side. Slide the 10mm Nylock nuts into the inner slot in the center of the mounting channels until they are aligned with bolts sticking through the base. Tighten the bolts firmly from below using the supplied 10mm wrench.



Hinge Side

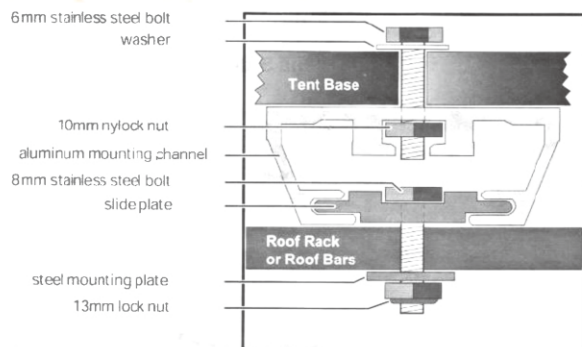

Autana Model ONLY

If you chose a side mounted orientation for the Autana Model, you will notice that the mounting channels extend beyond the edges of the base. You will need to mark each channel where they extend beyond the tent base and cut the mounting channels so they fit within the tent base. Fasten mounting channels to base as described above.

Attaching Ladder

Flip the tent base over. Locate the pre-drilled holes at the edge of the base and attach the ladder bracket to the base using 6mm bolts, washers, and nylock nuts.

After attaching both ladder brackets, position the ladder between the two brackets and attach to ladder brackets using 6mm bolt, a washer, and a nylock bolt on each side as shown in the diagram.

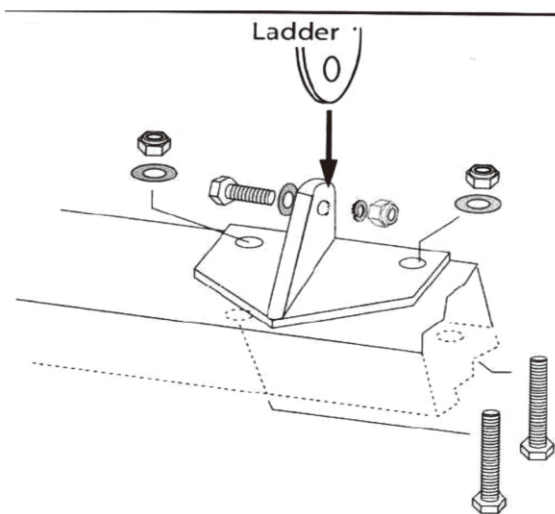

Placement of Tent onto your Roof Rack Bars

Place tent on top of your vehicle's rack system.

Place 13mm bolts into the slide plates. Slide the plates and bolts into the mounting channel. You will need to lift a tent side so as to have one of the 8mm bolts on the inside of the roof rack bar.

Inspect the position of the tent to ensure it is centered on the roof rack and positioned to open to the desired side.

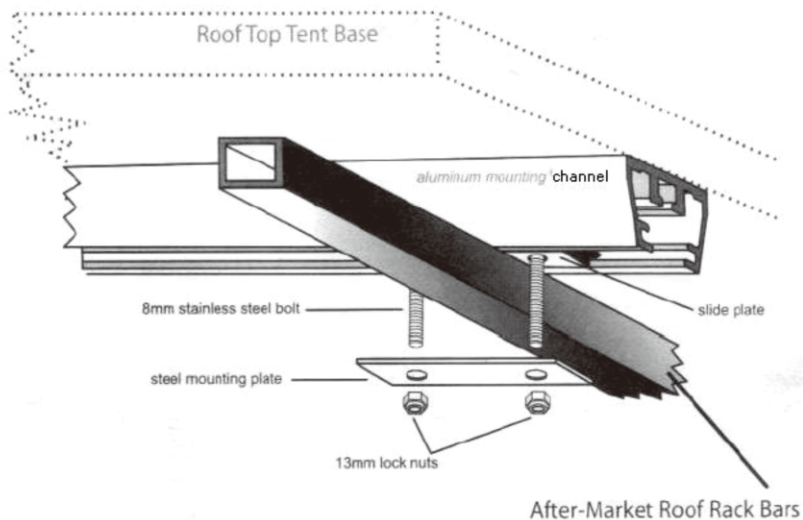

Attach the roof tent to your roof rack at the four points where the rack and mounting channels cross. Tighten all eight bolts securely. It is important that you check all the mounting bolts & brackets periodically to ensure they are securely fastened to your base and roof rack or after-market roof bars. After ensuring tent is positioned correctly and all eight bolts are tightened securely, insert rubber end caps into the ends of the mounting channel (this may require light taps from a hammer).

Cover Attachment

To attach the travel cover, slide the rounded fabric end of the cover into the rounded receiver channel at the hinge side of the tent base. Make sure the cover is oriented so the exterior side of the cover faces up when you pull the cover over the tent. The tent cover can be zipped to the base along the other three edges and two additional straps are provided to help secure the travel cover to the tent.



Tent Setup

1) Release the hold down Velcro straps at the side of the tent.



2) Remove the travel cover from the tent by unzipping around the 3 edges and roll the cover up.



3) Release the hold down Velcro straps at the side of the tent that are under the travel cover.



- 4) Slide the ladder out starting at the base of the ladder until the locking pins in each section engage. Use ladder as a lever to open the tent.



- 5) Allow the ladder to rest firmly on the ground. The tent base should be level with the ground while the ladder sits firmly on the ground making a 60° angle with the ground.

- 6) Assure all the steps on the telescoping ladder are locked. If you need to adjust the height of the telescoping ladder start with the top section and release the locking levers. Slide the ladder up so the top most section recedes fully into the section below it. Repeat this step for each section you wish to shorten the ladder by. Be sure to maintain a 60° angle between the ground and the ladder at all times and ensure that the remaining sections are fully locked if you adjust the ladder height as described above.



7) Climb ladder and enter tent. Release the bungee cords from side of the tent. Retrieve the steel tension rods. These are used to set up the window awnings and the rain fly. (You may need a step stool to perform this function if you have a taller vehicle.) Place the steel tension rod hook through the grommet on the awning or rain fly and then insert the other end through the lower grommet on the base skirt and into the hole at the base of the tent. This may require you to bend the rod slightly to align with the hole in the base. Repeat this process for both holes in the awnings and both holes at either end of the rain fly.



AUTANA MODEL ONLY - Your tent comes with a vestibule and canopy entrance. Further instructions are below.

Vestibule Attachment Instructions

AUTANA MODELS ONLY

The Autana models come with a vestibule and canopy entrance. The canopy entrance can be extended by removing the U-shaped canopy support bar from inside the tent and inserting it into the receiver tubes at either side of the tent base. After the canopy support bar is installed stretch the canopy over the bar and pull down towards the ground. The canopy can be secured to the ground by staking the ropes on either side of the canopy securely to the ground.

Please note that the travel cover will need to be removed prior to attaching the vestibule. The vestibule has a main entrance, two windows, and a rear entrance for access to your vehicle. The vestibule is attached to the tent base in a similar manner as the travel cover. To attach the vestibule slide the rounded fabric end of the vestibule into the rounded receiver channel at the hinge side of the tent base and zip on the other three sides. The floor attaches to the vestibule sides by zipping along all four sides. The vestibule should be staked out at all four corners to maximize interior space and properly secure the vestibule to the ground.



Storage and Handling

Every time that you come back from camping you should clean and dry your tent. Also, wash the mattress and cover once in a while (only hang dry). The following are the procedures:

1. Open the tent fully and brush / vacuum all dirt from inside of tent
2. Use a mild detergent with warm water and a soft to medium brush to clean the fabric as needed.
3. Rinse fabric of all detergent prior to drying.
4. Let it dry under the sun with all windows open. It is important that the tent is completely dry before storage or mildew and mold may occur. This is especially necessary after camping in rain or wet conditions.
5. Using a small brush, remove dirt from the zippers. Also, use a silicon spray to keep them lubricated.

Limited Warranty

What Is Covered

Roof Top tents , warrants to the original purchaser that its products are free from defects in material and workmanship, for the term described, except as qualified below. The life of the product is determined from the date of purchase until such time as the product is no longer serviceable due to normal wear and tear.

What Is Not Covered We

shall not be responsible for the natural breakdown of materials that occurs inevitably with extended use (e.g., Ultra Violet (UV) light damage on tents, exhausted zippers), or defects caused by accident, abuse, alteration, animal attack, storm damage, misuse or improper care.

Some states do not allow the exclusion or limitation of incidental or consequential damages, so the above limitation or exclusion may not apply to you.

What We Will Do

If after inspection we find that a product failed due to a manufacturing or material defect, we will repair or replace the product, at our option, without charge.

How To Obtain Warranty Service

Return the product, freight prepaid, to the **Roof Top Tents Dealer** from whom it was purchased; or, contact the Customer Satisfaction Department for return authorization. Collect shipments or shipments without return authorization cannot be accepted.

REPAIRS

If your **Roof Top Tent** product needs service or repair due to normal wear and tear, animal attack, accident or some other reason that is not covered under the warranty we will provide the necessary service for a reasonable charge, plus shipping and handling. We require that products accepted for any repair be properly cleaned according to our recommended care instructions. Please send your product or component that requires repair (e.g., tent fly), postage prepaid, along with a description of what needs attention. For service and repairs, please contact our Customer Satisfaction Department.

How State Law Relates To This Warranty

This warranty gives you specific legal rights, and you may have other rights that vary from state to state.

Warranty Term

Limited one year warranty applies to all tent components including base, aluminum poles, ladder, fabric and seams.

DATED:

