

# INSTALLATION INSTRUCTIONS

## K4 ROLL BAR

### Before Installation

- Please read the instruction completely for easy installation, which will also help you to avoid scratches or other potential damages to your appealing car.
- The information shown here is for reference only and may differ from the product that you receive, however the goods are fitted in the same way.



### Care and Cleaning

- Mild soap may be used also to clean the Product.
- Please periodically check and retighten all the hardware and clean the investment for a refresh look.

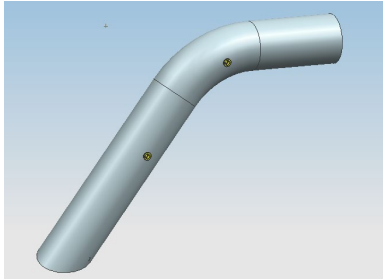
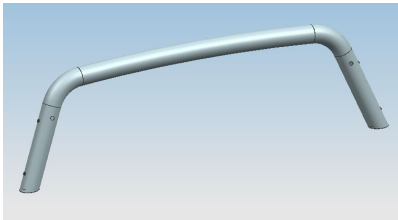
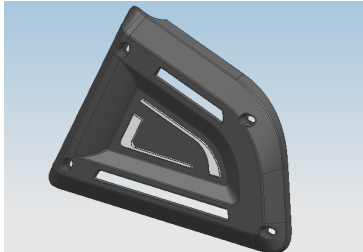
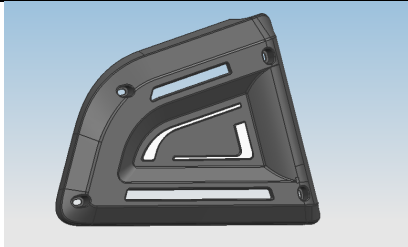
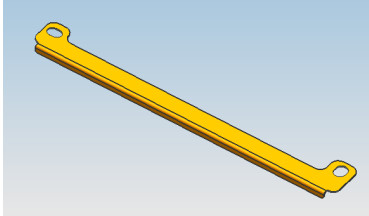

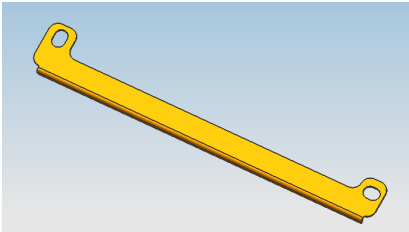
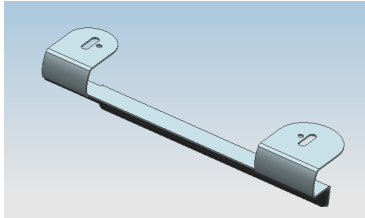
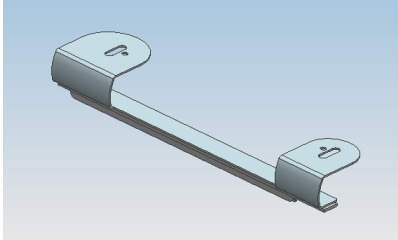
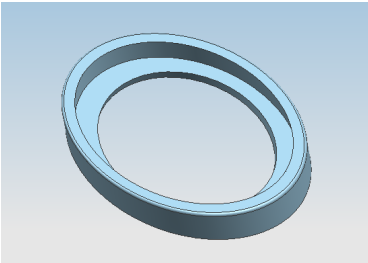
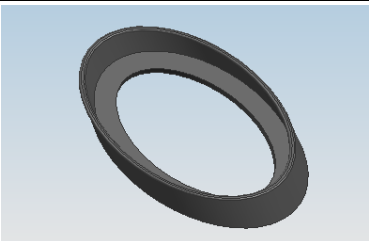
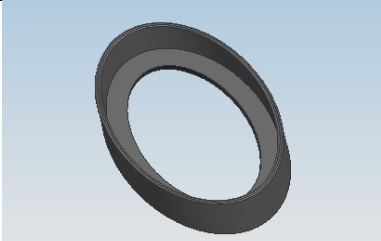
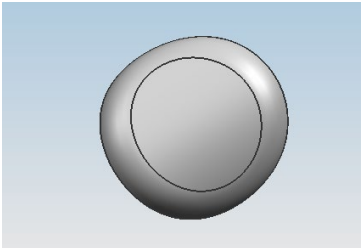
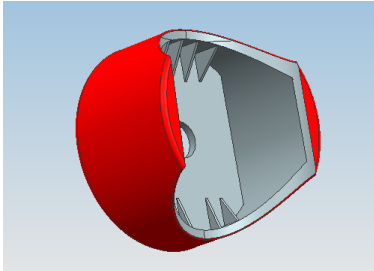
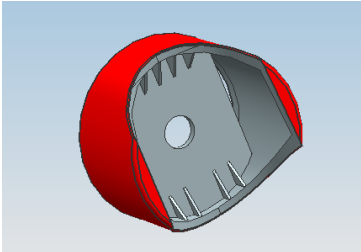

### Parts list

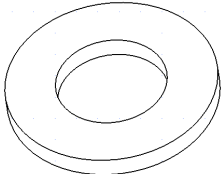
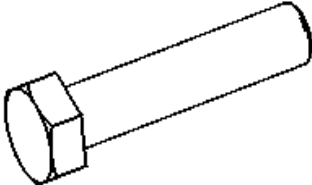
NO.	QTY	PICTURE	NO.	QTY	PICTURE
①	1	 Side tube(L)	②	1	 Side tube(R)
③	1	 Main tube	④	1	 Side plate(L)
⑤	1	 Side plate(R)	⑥	1	 Side plate reinforced bracket(L)

# INSTALLATION INSTRUCTIONS

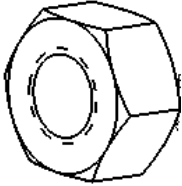
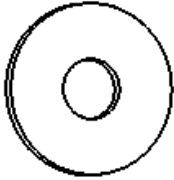
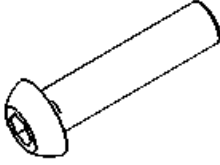
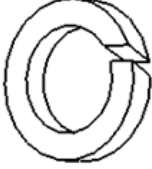
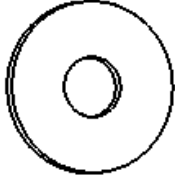
⑦	1		⑧	1	
		Side plate reinforced bracket(R)			Base bracket(L)
⑨	1		⑩	2	
		Base bracket(R)			Front rubber footing
⑪	1		⑫	1	
		Rear rubber footing(L)			Rear rubber footing (R)
⑬	2		⑭	1	
		Rubber plug			Rubber joint(L)
⑮	1		⑯	1	
		Rubber joint(R)			Allen wrench S=4
⑰	2		⑱	4	
		Flat washer D10			Hex nut M8_40

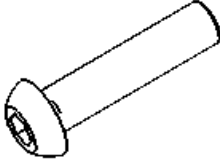
# INSTALLATION INSTRUCTIONS

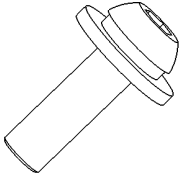
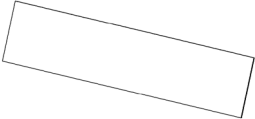
⑲	4	 Hex nut M8	⑳	8	 Flat washer D8
㉑	4	 Button head allen bolts M10_40	㉒	4	 SPRING WASHER D8
㉓	4	 Flat washer D10	㉔	6	 SPRING WASHER D10
㉕	2	 Button head allen bolts M10_50	㉖	1	 Allen wrench S=6
㉗	8	 BUTTON HEAD BOLT ASSEMBLY M6_20	㉘	2	 Logo sticker

# INSTALLATION INSTRUCTIONS

## Installation Steps

### Installation Diagram

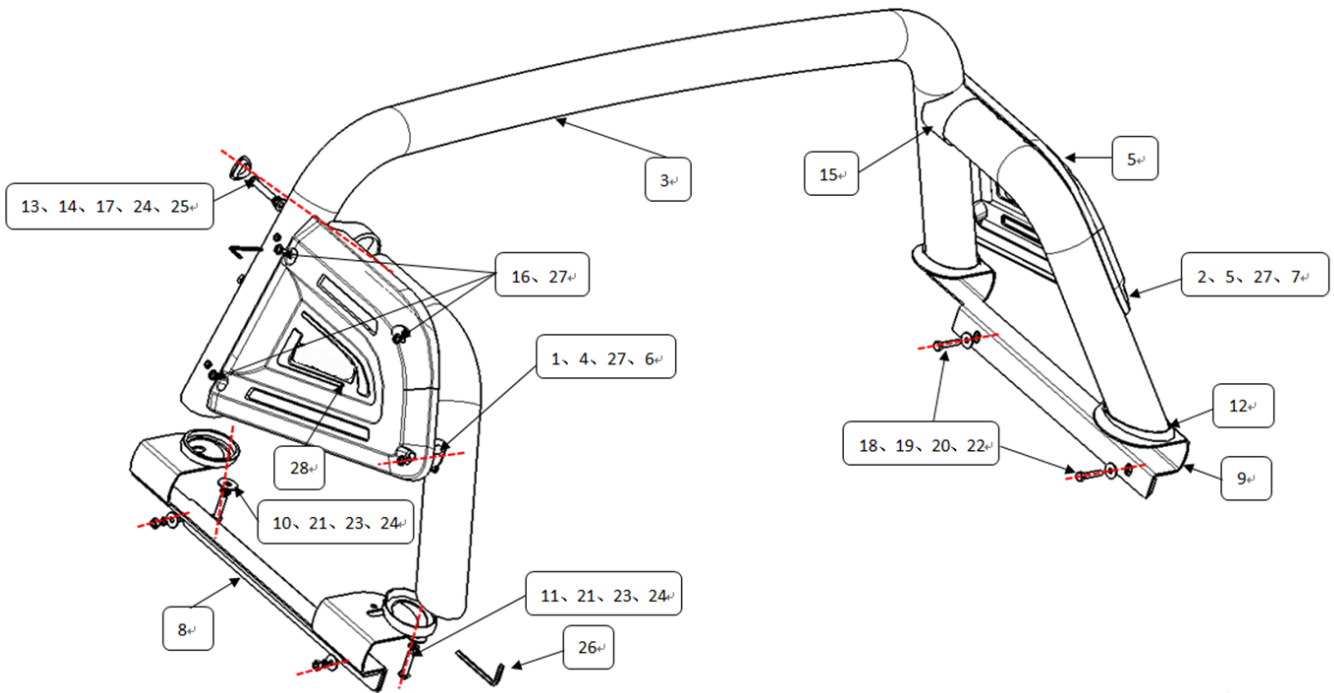

Step 1: Verify all parts are present.

Step 2: Please assemble the roll bar as shown in above diagram, and install to the bed of your pickup (Please noted drilling on side rail needed.)

Step 3: Test and make sure that the roll bar is steadily fixed, fully tighten all hardware.

Step 4: Installation is finished, pick up all tools.

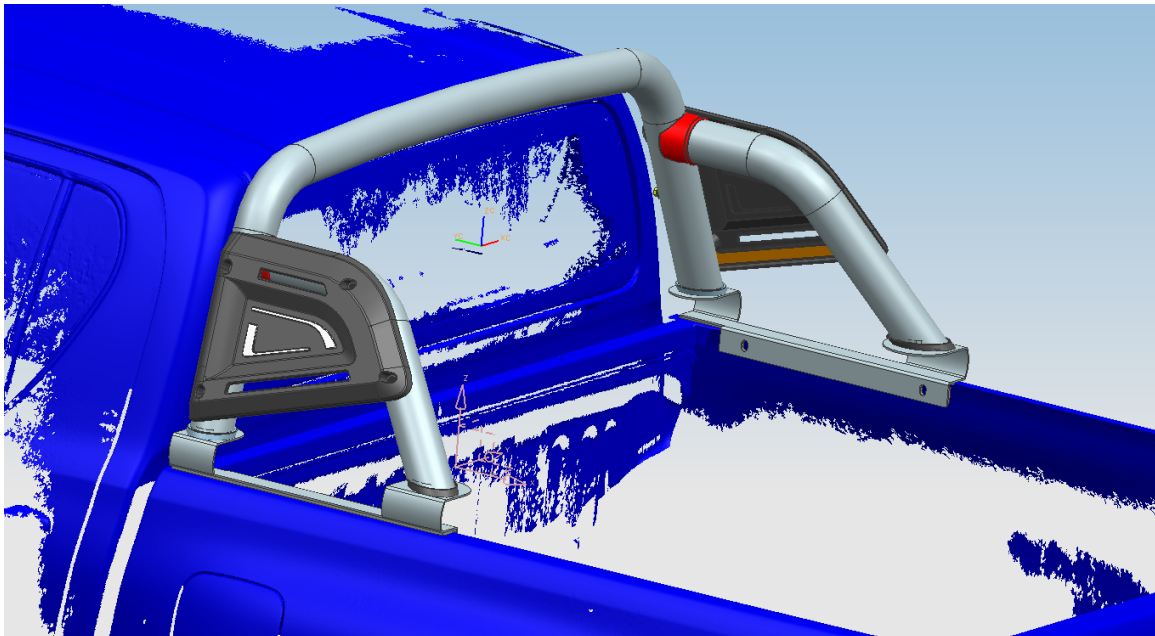

●NOTE: Any damages and losses caused by improper installation and application, goes beyond our quality warranty.